

15" FLAT BOTTOM FLARED END SECTION W/MODIFIED BELL

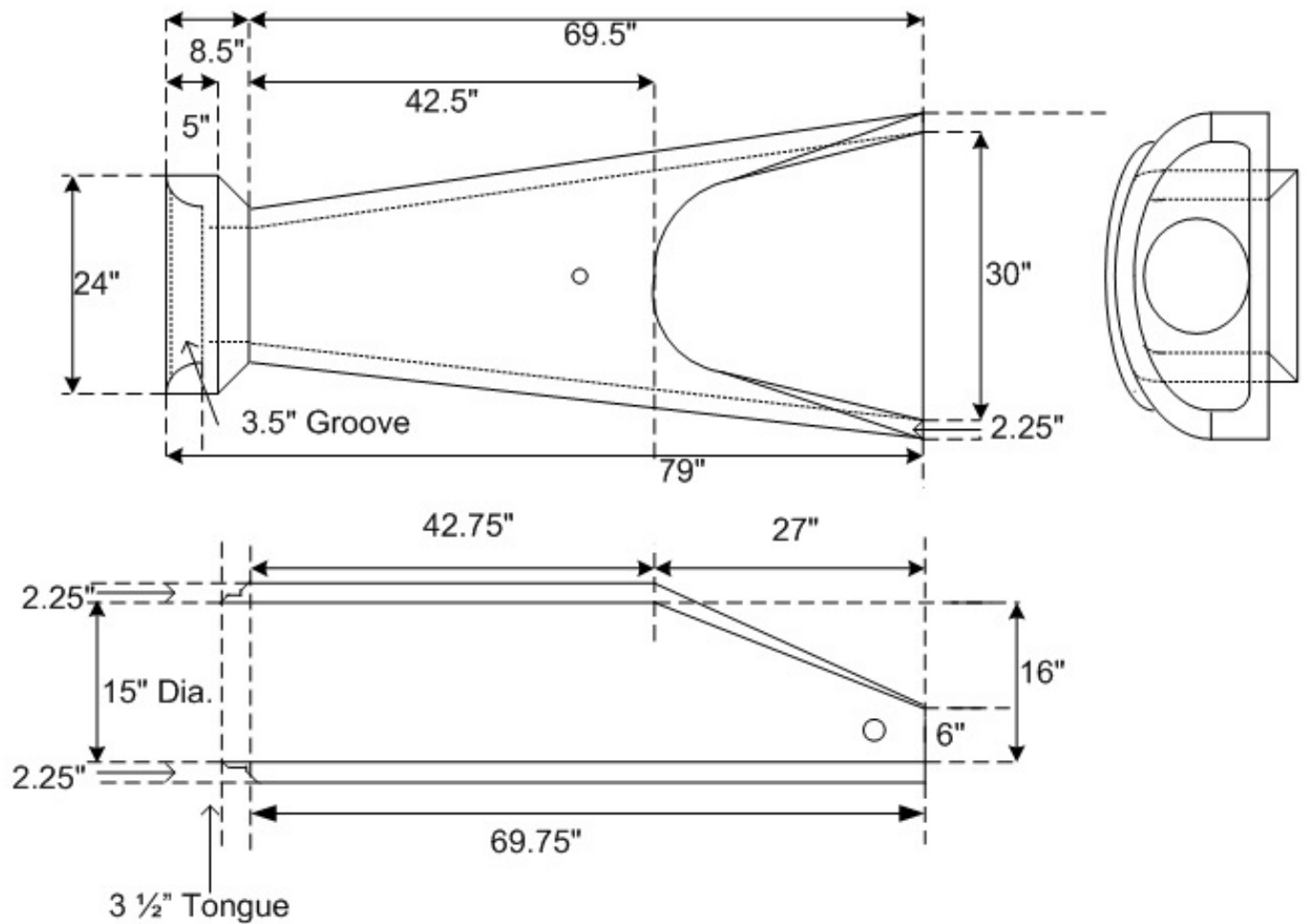

2121 Maple Road
 Joliet, IL 60432
 Phone: (815)726-3351
 Fax: (815) 726-2945

15" FLAT
 BOTTOM
 FLARED END
 SECTION W/
 MODIFIED BELL

For pricing information,
 phone, fax or email
estimate@norwalktank.com